

**D** Streuwagen WE 252, 5426 080

**GB** All Purpose Spreader WE 252, 5426 080

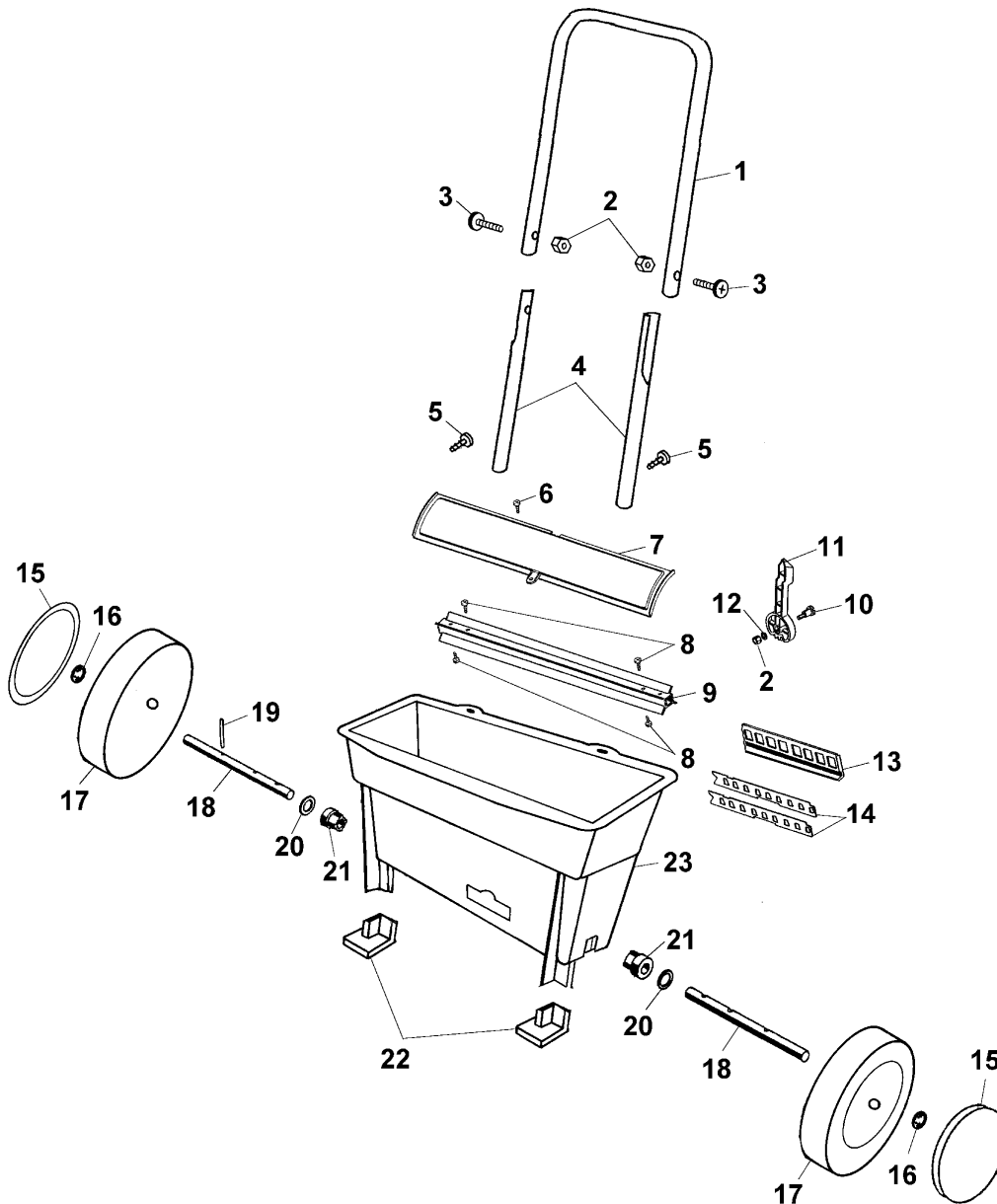

## WE 252

Bild-Nr. / Ref. No.	Best.-Nr. / Part No.	Bezeichnung	Description
1	5426 115	Griffoberteil	upper handlebar
2	0016 310	6kt.-Mutter (3 St.)	hex. screw (3 pieces)
3	0012 961	Linsenschraube (2 St.)	screw (2 pieces)
4	5426 120	Griffunterteil (2 St.)	lower handlebar
5	0015 684	Linsenbl.-Schraube (2 St.)	screw (2 pieces)
6	0012 625	PT-Schraube	screw
7	5426 321	Abdeckung	cover
8	0015 822	Blech-Schraube (4 St.)	sheet metal screw (4 p.)
9	5426 401	Streuwelle	spreader roll
10	5420 203	Lagerbolzen	bolt
11	5426 303	Einstellhebel	adjusting lever
12	0017 120	Scheibe	washer
13	5426 323	Verstellschiene	adjusting mechanism
14	5426 400	Streublech (2 St.)	spreader metal
15	4936 535	Deckel Ø 170 mm (2 St.)	hub cap 170 mm dia. (2 p.)
16	0020 696	Wellensicherung (2 St.)	circlip (2 pieces)
17	5426 500	Laufgrad Ø 200 mm (2 St.)	wheel 200 mm dia. (2 piec.)
18	5426 110	Achse (2 St.)	axle (2 pieces)
19	0018 815	Spannstift	dowel pin
20	0017 203	Scheibe (2 St.)	washer (2 pieces)
21	5426 322	Buchse (2 St.)	bush (2 pieces)
22	5426 324	Fuß (2 St.)	base (2 pieces)
23	5426 014	Streubehälter	spreader receptacle
***	0054 325	Gebrauchsanweisung	operator manual